

De 4 dobbelstenen zo leggen, dat steeds 4 verschillende kleuren rechtlijnig tegen elkaar liggen.

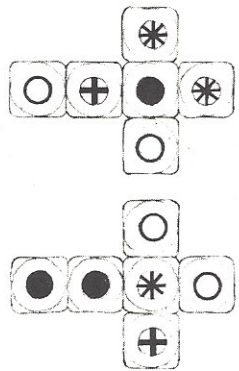

Put the 4 dice in such a way, that 4 different colours are always visible on each long side.

○ = orange / orange / arvet  
 + = blauw / bleu / blau / blue / blue / blå

Posez les 4 dés de telle façon que toujours 4 couleurs différentes se touchent en ligne droite.

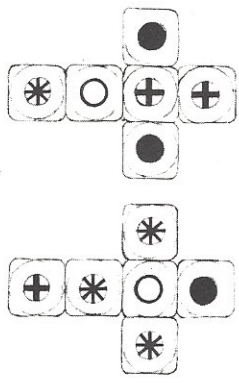

Legen Sie die 4 Farbenwürfel so, dass immer 4 verschiedene Farben geradlinig aneinanderliegen.

\* = rood / rouge / rot / red / rød / rød  
 ● = groen / vert / grün / green / grøn / grøn

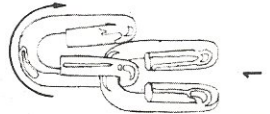

1

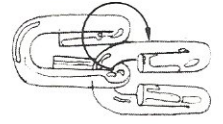

2

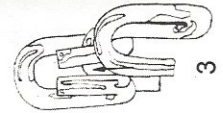

3

Posez les 4 dés de telle façon que toujours 4 couleurs différentes se touchent en ligne droite.

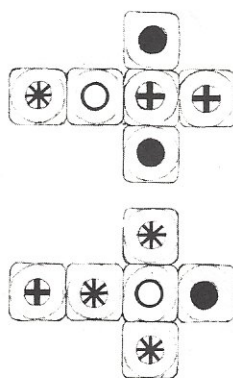

Legen Sie die 4 Farbenwürfel so, dass immer 4 verschiedene Farben geradlinig aneinanderliegen.

\* = rood / rouge / rot / red / rød / rød  
 ● = groen / vert / grün / green / grøn / grøn

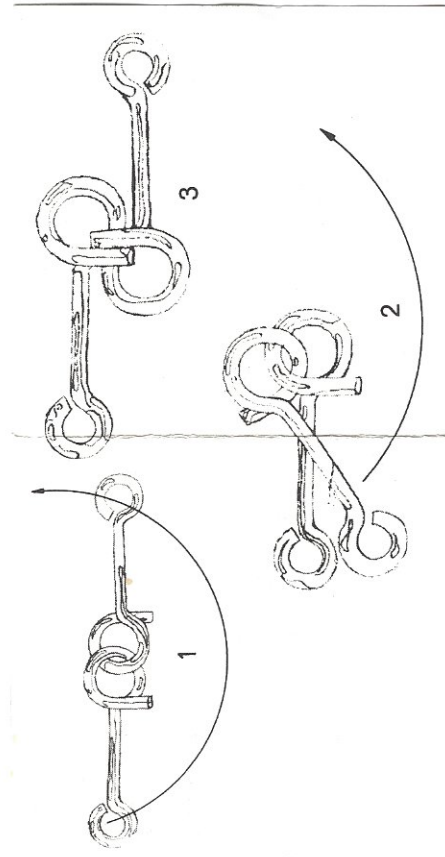
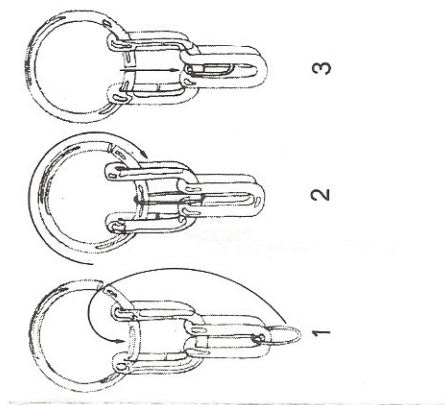
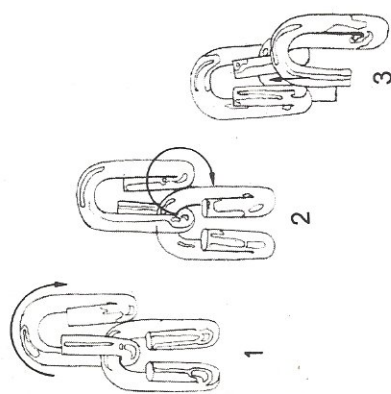

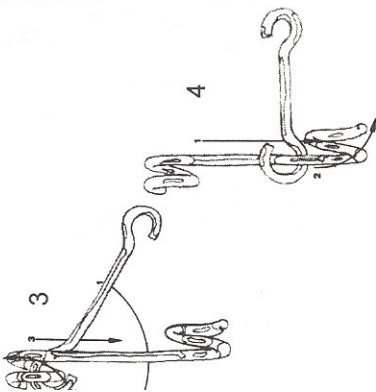

4

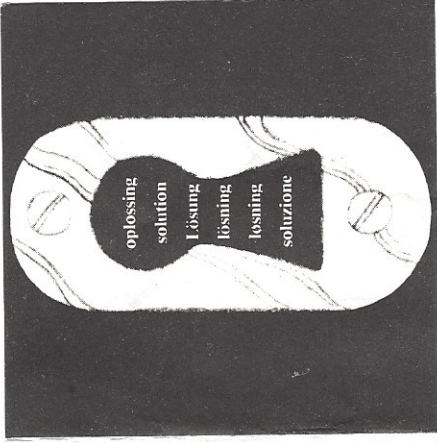
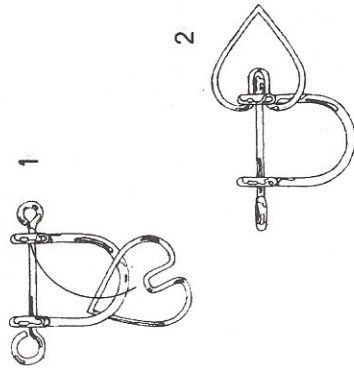
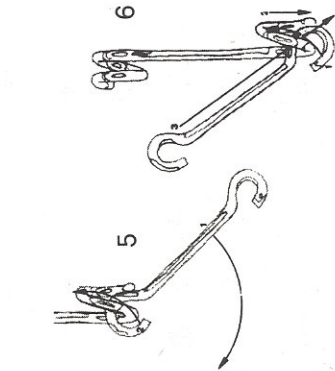

SPELLENTUUR®  
JAMES SPEL  
Jumbo  
SPELLENTUUR®

No 112

© Hausemann & Hötte nv Amsterdam

Printed in the Netherlands

03 77

